



# Richards-Wilcox®

Garage Doors

# THERMATITE®

## SECTIONAL OVERHEAD CATALOGUE

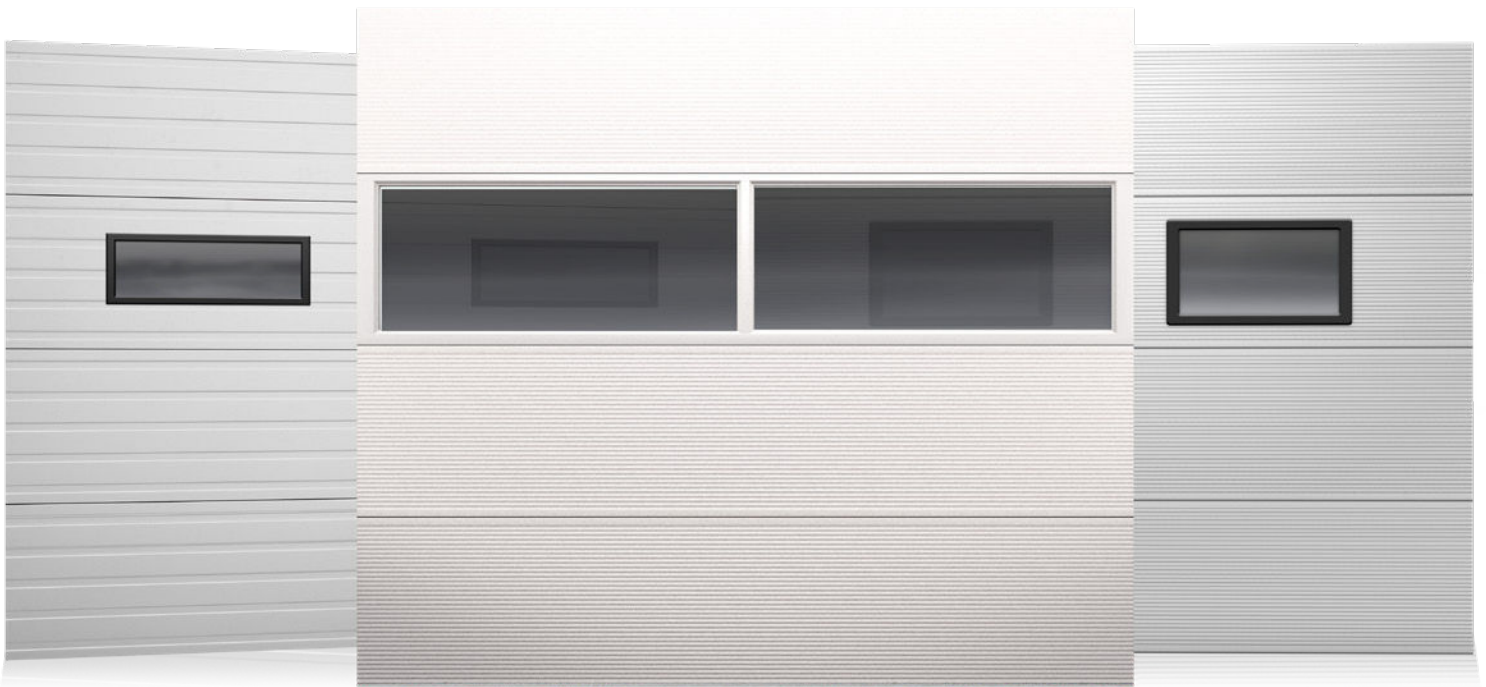

[www.rwdoors.com](http://www.rwdoors.com)



MADE IN CANADA

# WHY RICHARDS-WILCOX?

Richards-Wilcox was incorporated in Canada in 1912, making us the oldest door company in the world. We're proud of our long history of quality products and we've built upon that history to bring you the exceptional line of garage doors we offer today.

At Richards-Wilcox, we are committed to making the next chapter of our history just as exciting as the first. We are passionate innovators of garage door design and desire to be the highest quality door systems manufacturer in the world.



## NEUFOAM™ TECHNOLOGY

High-density polyurethane insulation in a computer controlled continuous process provides uniform cavity-free insulation, superior adhesion and excellent strength.



## WEATHERLOCK™ SYSTEM

WeatherLock™ Section Joint, Dual Fin Triple Contact Weather Seal and Arctic Grade Bulb Shaped Bottom Seal with a Dual Contact bottom retainer for the full width of the door.



## LINEAR HARDWARE

With today's newest technology and panel construction, most manufacturers still use hardware designed for wood doors. With R-W's exclusive linear designed hinges and trussing, we've achieved one of the greatest strength-to-weight ratio's in the industry.



## R-W AUTHORIZED DEALERS

A door is only as good as its installation. That's why our doors are only installed by Authorized Dealers. This process ensures that every installation meets our standards of quality. There are over 100 R-W dealers across Canada.



## MADE IN CANADA

Richards-Wilcox Canada has been in business for over 100 years. From parts, hardware to panels, R-W doors are proudly made in Canada.

## UNIQUE MULTI-RIBBED (MR) PROFILE

- Multi-Ribbed profile complements contemporary architecture.
- Perfect choice when aesthetics are a key consideration.
- Non-repeating stucco surface texture resists scratches and dirt



Multi-Ribbed

## RIBBED PROFILE

- Recognized as a standard look on many door systems that are already installed.
- R-W can provide matching section replacement options to customers quickly and efficiently.

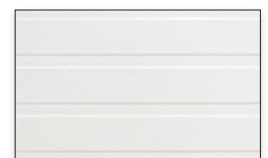

Ribbed

# THE THERMATITE® SERIES



## THERMATITE DOORS

	<b>T175 (Pg 4 &amp; 5)</b>	<b>T150 (Pg 6 &amp; 7)</b>	<b>T200 (Pg 6 &amp; 7)</b>	<b>T200C (Pg 8 &amp; 9)</b>	<b>T300 (Pg 10 &amp; 11)</b>	<b>T200-20 (Pg 12 &amp; 13)</b>
<b>Face Material</b>	Steel	Steel	Steel	Steel	Steel	Steel
<b>Door Width (recommended max.)</b>	36'-2" (11024mm)	24'-2" (7366mm)	30'-2" (9195mm)	24'-2" (7366mm)	36'-2" (11024mm)	36'-2" (11024mm)
<b>Door Height (max.)</b>	22' (6706mm)	22' (6706mm)	22' (6706mm)	22' (6706mm)	22' (6706mm)	22' (6706mm)
<b>Section Thickness</b>	1 3/4" (45mm)	1 1/2" (38mm)	2" (51mm)	2" (51mm)	3" (76mm)	2" (51mm)
<b>Section Joint</b>	1/4" (6mm) Ship-Lap	1/4" (6mm) Ship-Lap	1/4" (6mm) Ship-Lap	Tongue and Groove	Tongue and Groove	1/4" (6mm) Ship-Lap
<b>R-Value (Calculated)</b>	<b>16.00</b>	<b>13.21</b>	<b>18.28</b>	<b>18.28</b>	<b>24.54</b>	<b>18.28</b>
<b>Exterior Face Sheet Thickness</b>	0.019" (0.48mm)	0.016" (0.41mm)	0.016" (0.41mm)	0.016" (0.41mm)	0.019" (0.48mm)	0.037" (0.94mm)
<b>Standard Exterior Finishes</b>	White, Silver & Brown	White, Silver & Brown	White	Almond, Sandstone, Desert Tan, Brown, Bronze, Black, Slate Grey, Cafe, Iron Ore	White	White
<b>Pattern</b>	Multi-Ribbed/ Standard Ribbed	Multi-Ribbed/ Standard Ribbed	Multi-Ribbed/ Standard Ribbed	Multi-Ribbed/ Standard Ribbed	Multi-Ribbed/ Standard Ribbed	Flush
<b>Glazing (See pg 14 &amp; 15 for more details)</b>	AA, B, CPL, D, E, Fullview	AA, B, CPL, D, E, Fullview	AA, B, CPL, D, E, Fullview	AA, B, CPL, D, E, Fullview	CPL, D, E, Fullview	AA, B, CPL, D, E, Fullview



## **T175** The Flagship Thermatite Door

The T175 was the first door utilizing the Richards-Wilcox's continuous Neufoam polyurethane technology and continues to be our top selling Commercial/Industrial door for over 30 years carrying with it a reputation of reliability and durability exceeding the expectations of daily use. It offers the widest selection of quality features and options for the most common product applications.

# PRODUCT SPECIFICATIONS

## SECTION DETAILS

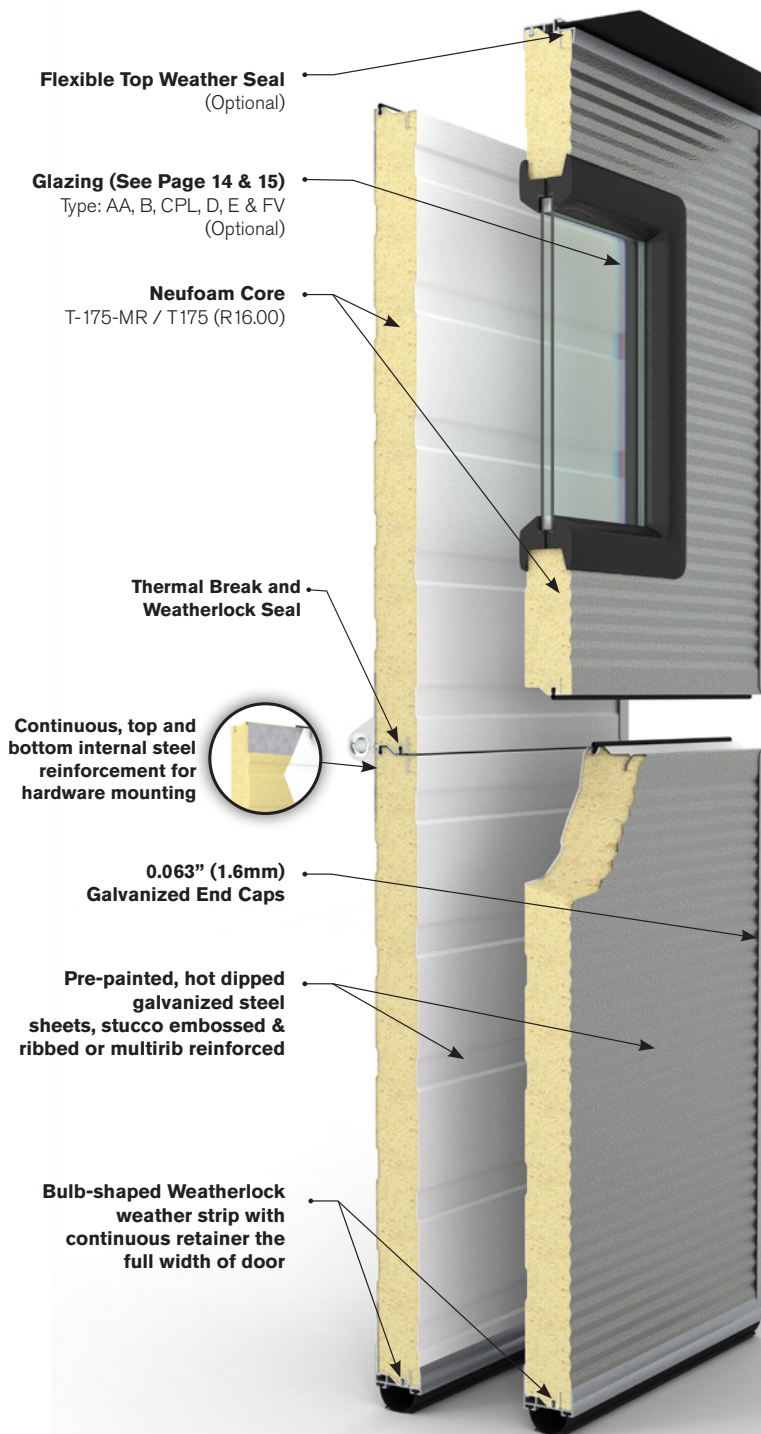

**Flexible Top Weather Seal**  
(Optional)

**Glazing (See Page 14 & 15)**  
Type: AA, B, CPL, D, E & FV  
(Optional)

**Neufoam Core**  
T-175-MR / T175 (R16.00)

**Thermal Break and Weatherlock Seal**

**Continuous, top and bottom internal steel reinforcement for hardware mounting**

**0.063" (1.6mm) Galvanized End Caps**

**Pre-painted, hot dipped galvanized steel sheets, stucco embossed & ribbed or multirib reinforced**

**Bulb-shaped Weatherlock weather strip with continuous retainer the full width of door**

**SECTION THICKNESS** 1 3/4" (45mm)

**THERMAL VALUE OF SECTIONS\***  
R 16 ft<sup>2</sup> hF/Btu

**EXTERIOR FACE SHEET PROFILE**  
Multi-Ribbed / Ribbed

**FACE SHEET THICKNESS** 0.019" (0.48mm)

**MAXIMUM OPENING WIDTH\*\*** 36'-2" (11024mm)

**MAXIMUM OPENING HEIGHT\*\*** 22' (6706mm)

**FINISH** Two coat, baked-on paint system on exterior side, primer and polyester finish coat.

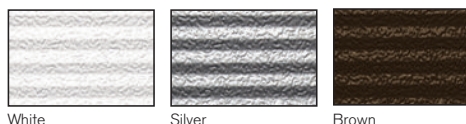

## GLAZING OPTIONS

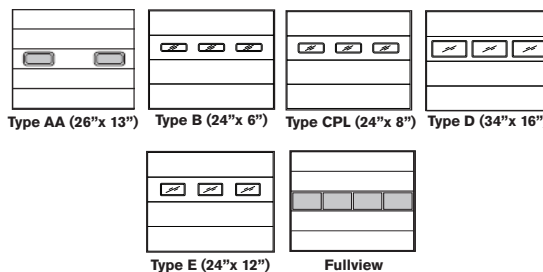

## WARRANTY

**10 years** against delamination of the panels  
**1 year** on materials and workmanship

## SECTION SCHEDULE

DOOR OPENING HEIGHT	Sections High	DOOR OPENING WIDTH	Default Number of Windows
7'-1" to 8'-1" (2159mm to 2464mm)	4	8'-0" to 9'-2" (2438mm to 2794mm)	2
8'-2" to 10'-1" (2489mm to 3073mm)	5	9'-3" to 12'-2" (2819mm to 3708mm)	3
10'-2" to 12'-1" (3099mm to 3683mm)	6	12'-3" to 16'-2" (3734mm to 4928mm)	4
12'-2" to 14'-1" (3708mm to 4293mm)	7	16'-3" to 19'-2" (4953mm to 5842mm)	5
14'-2" to 16'-1" (4318mm to 4902mm)	8	19'-3" to 24'-2" (5867mm to 7366mm)	6
16'-2" to 18'-1" (4928mm to 5512mm)	9	24'-3" to 36'-2" (7391mm to 11024mm)	7

\*Thermal Values Calculated. \*\*For larger sizes, please consult factory.



## T150

### **The Perfect Dock Door**

The T150 offers a 1.5" of Neufoam™ Core and an energy efficient R-Value of 13.21. Other popular applications include warehousing, small commercial buildings and shops.

## T200

### **Energy Efficient Workhorse**

The T200 offers a 2" Neufoam™ Core and an R-Value of 18.3. Its great for a wide variety of commercial and industrial applications where higher insulation levels are desired.

# PRODUCT SPECIFICATIONS

## SECTION DETAILS

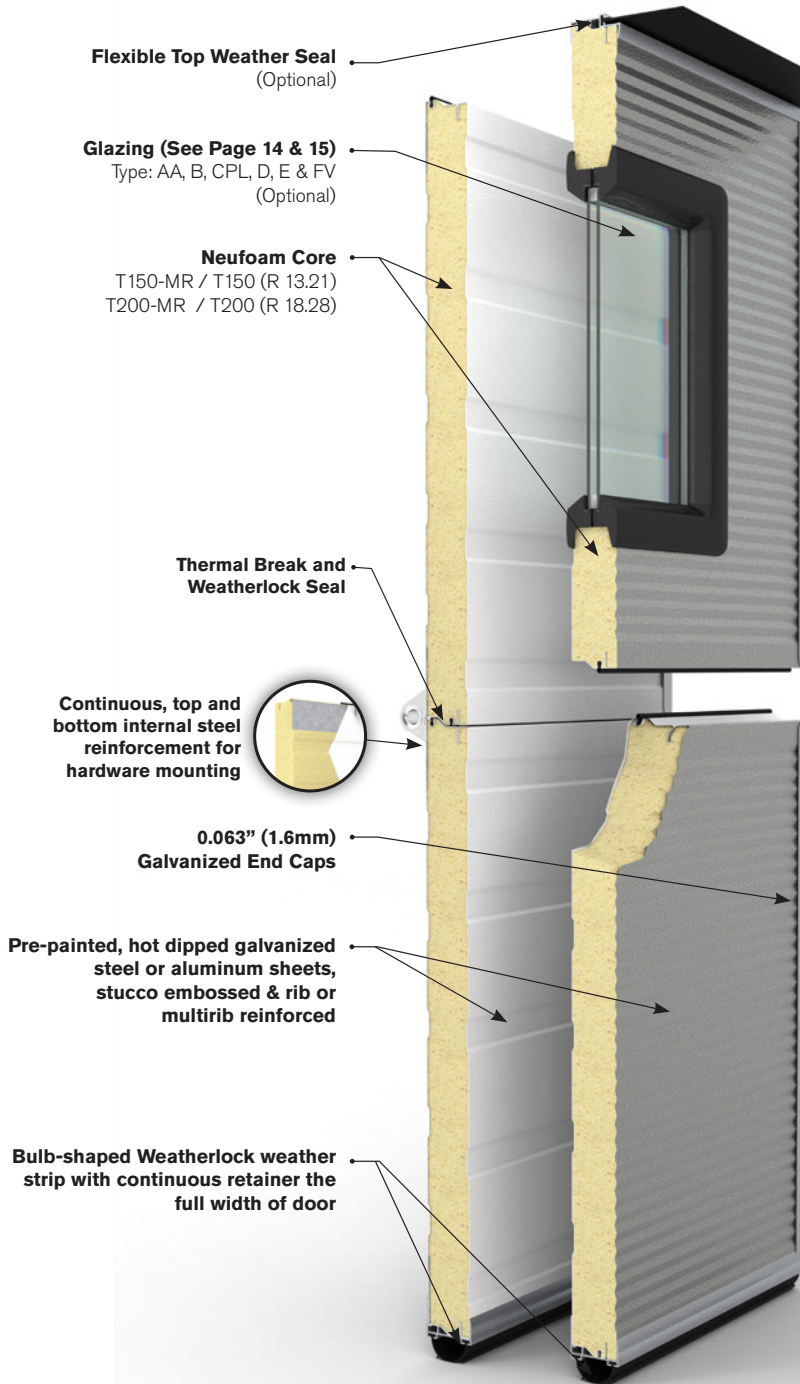

### SECTION THICKNESS

T150-MR / T150	1 1/2" (38mm)
T200-MR / T200	2" (51mm)

### THERMAL VALUE OF SECTIONS\*

T150-MR / T150	R 13.21 ft <sup>2</sup> hF/Btu
T200-MR / T200	R 18.28 ft <sup>2</sup> hF/Btu

### FACE SHEET PROFILE

T150-MR / T150	Multi-Ribbed / Ribbed
T200-MR / T200	Multi-Ribbed / Ribbed

### EXTERIOR FACE SHEET THICKNESS

T150-MR / T150	0.016" (0.41mm)
T200-MR / T200	0.016" (0.41mm)

### MAXIMUM OPENING WIDTH\*\*

T150-MR / T150	24'-2" (7366mm)
T200-MR / T200	30'-2" (9195mm)

### MAXIMUM OPENING HEIGHT\*\*

All models	22' (6706mm)
------------	--------------

### FINISH

Two coat, baked-on paint system on exterior side, primer and polyester finish coat.

T150-MR / T150	White / Silver / Brown
T200-MR / T200	White



## GLAZING OPTIONS

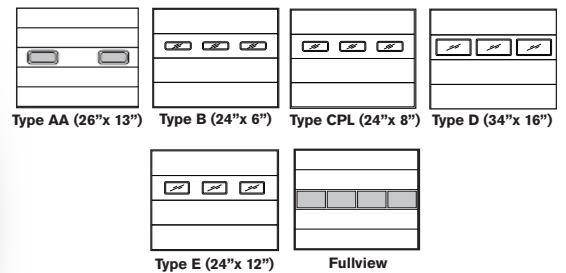

## SECTION SCHEDULE

DOOR OPENING HEIGHT	Sections High	DOOR OPENING WIDTH	Default Number of Windows
7'-1" to 8'-1" (2159mm to 2464mm)	4	8'-0" to 9'-2" (2438mm to 2794mm)	2
8'-2" to 10'-1" (2489mm to 3073mm)	5	9'-3" to 12'-2" (2819mm to 3708mm)	3
10'-2" to 12'-1" (3099mm to 3683mm)	6	12'-3" to 16'-2" (3734mm to 4928mm)	4
12'-2" to 14'-1" (3708mm to 4293mm)	7	16'-3" to 19'-2" (4953mm to 5842mm)	5
14'-2" to 16'-1" (4318mm to 4902mm)	8	19'-3" to 24'-2" (5867mm to 7366mm)	6
16'-2" to 18'-1" (4928mm to 5512mm)	9	24'-3" to 30'-2" (7391mm to 9195mm)	7

## WARRANTY

**10 years against delamination of the panels  
1 year on materials and workmanship**

\*Thermal Values Calculated. \*\*For larger sizes, please consult factory.



# **STRONG. DURABLE. VIBRANT!**

## **T200C Thermatite Sectional Insulated Steel Door**

The same great quality and durability you get from every model in the Thermatite Series.

### **AVAILABLE IN 9 COLOURS OPTIONS**

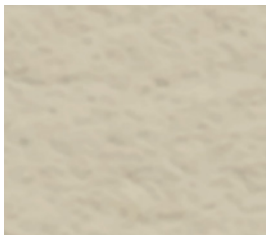

Almond



Black



Bronze

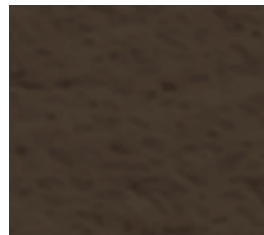

Brown

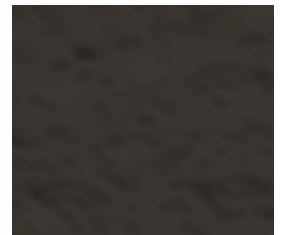

Café



Desert Tan

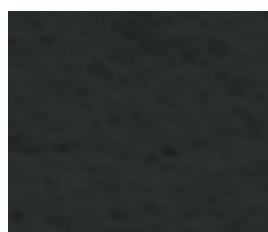

Iron Ore

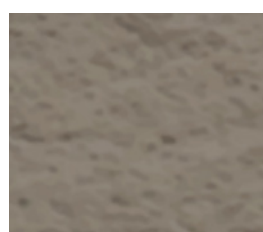

Sandstone

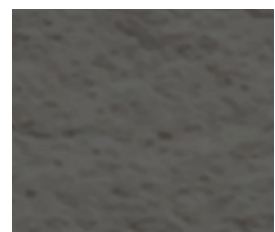

Slate Grey

# PRODUCT SPECIFICATIONS

# SECTION DETAILS

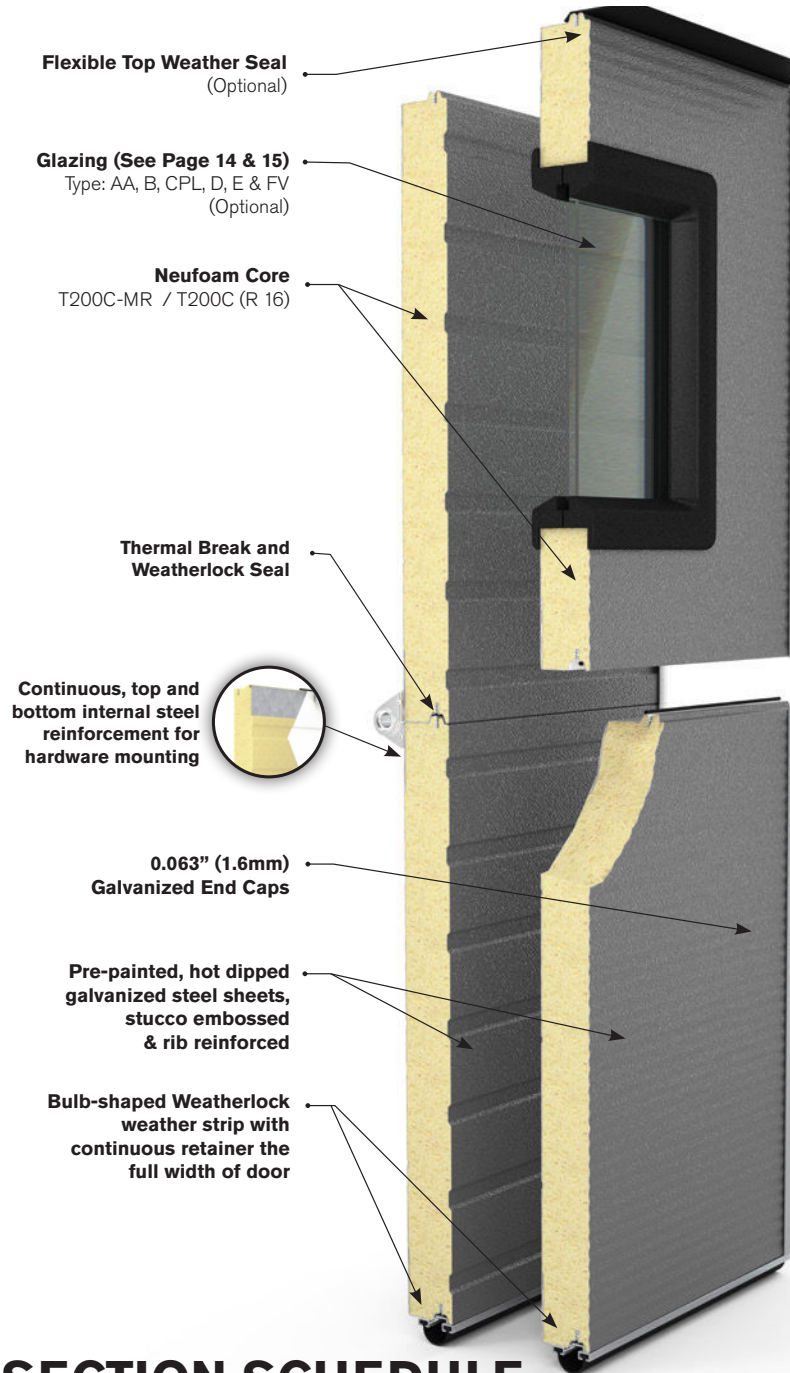

**SECTION THICKNESS** 2" (51mm)

**THERMAL VALUE OF SECTIONS\***  
**R** 18.28 ft<sup>2</sup> hF/Btu

**FACE SHEET PROFILE** Multi-Ribbed / Ribbed

**EXTERIOR FACE SHEET THICKNESS**  
 .016" (.41mm)

**MAXIMUM OPENING WIDTH\*\*** 24'-2" (7366mm)

**MAXIMUM OPENING HEIGHT** 22' (6706mm)

**FINISH** Two coat, baked-on paint system on exterior side, primer and polyester finish coat.



## GLAZING OPTIONS

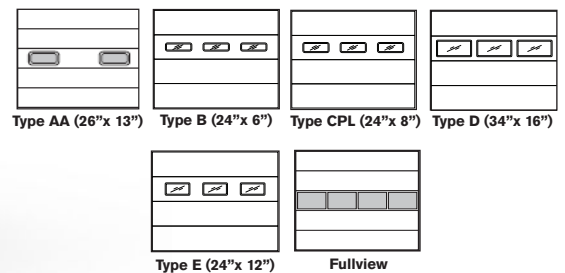

# SECTION SCHEDULE

DOOR OPENING HEIGHT	Sections High	DOOR OPENING WIDTH	Default Number of Windows
7'-1" to 8'-1" (2159mm to 2464mm)	4	8'-0" to 9'-2" (2438mm to 2794mm)	2
8'-2" to 10'-1" (2489mm to 3073mm)	5	9'-3" to 12'-2" (2819mm to 3708mm)	3
10'-2" to 12'-1" (3099mm to 3683mm)	6	12'-3" to 16'-2" (3734mm to 4928mm)	4
12'-2" to 14'-1" (3708mm to 4293mm)	7	16'-3" to 19'-2" (4953mm to 5842mm)	5
14'-2" to 16'-1" (4318mm to 4902mm)	8	19'-3" to 24'-2" (5867mm to 7366mm)	6
16'-2" to 18'-1" (4928mm to 5512mm)	9		

# WARRANTY

**10 years against delamination of the panels**  
**1 year on materials and workmanship**

\*Thermal Values Calculated. \*\*For larger sizes, please consult factory.



## **T300** 3" Thick Powerhouse Commercial Door

The ultimate choice for thermal efficiency with a 24.54 R-value. The T300 is ideal for commercial warehousing, agriculture, fire hall & ambulance bays, refrigerated buildings, underground parking and high security facilities.

# PRODUCT SPECIFICATIONS

## SECTION DETAILS

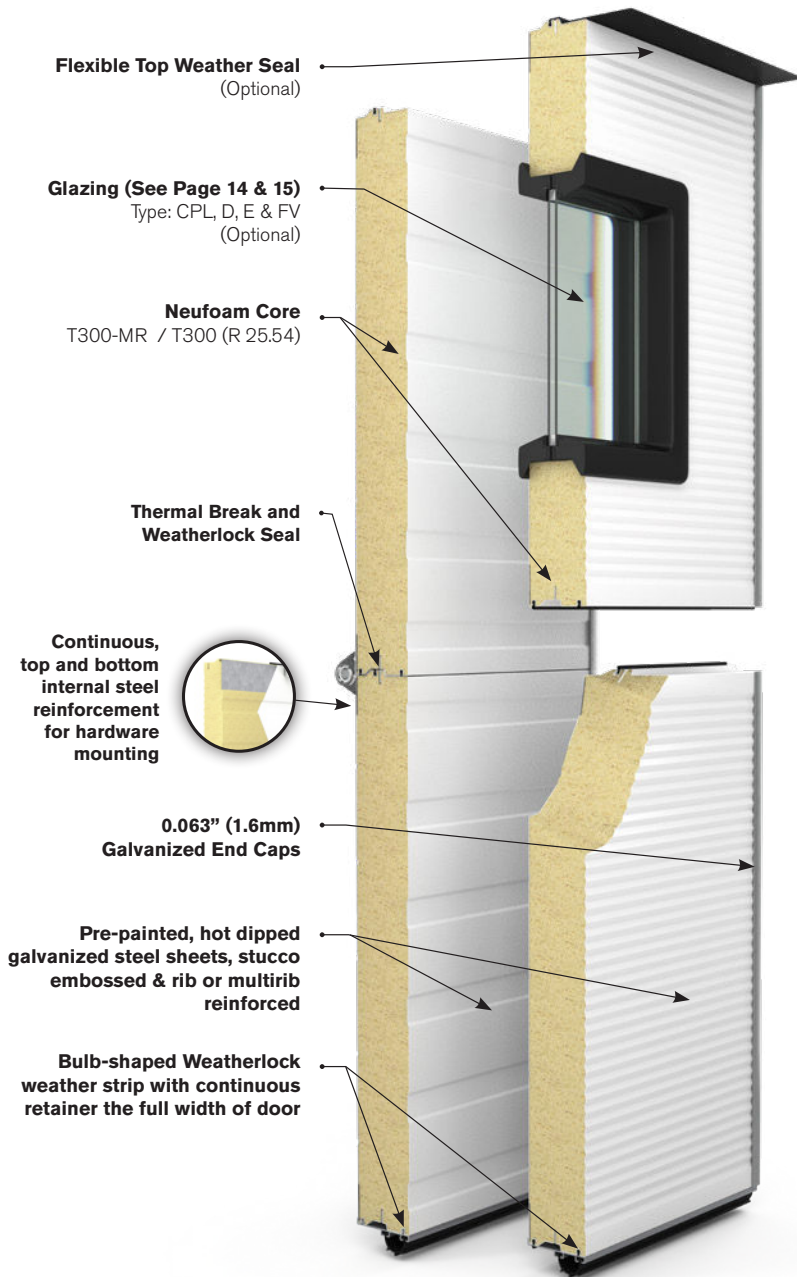

**DOOR THICKNESS** 3" (76 mm)

**THERMAL VALUE OF SECTIONS\***  
R 24.54 ft<sup>2</sup> hF/Btu

**FACE SHEET PROFILE** Multi-Ribbed / Ribbed

**EXTERIOR FACE SHEET THICKNESS**  
0.019" (0.48mm)

**MAXIMUM OPENING WIDTH\*\***  
36'-2" (11,024mm)

**MAXIMUM OPENING HEIGHT\*\*** 22' (6706mm)

**FINISH** Two coat, baked-on paint system on exterior side, primer and polyester finish coat.



White

## GLAZING OPTIONS

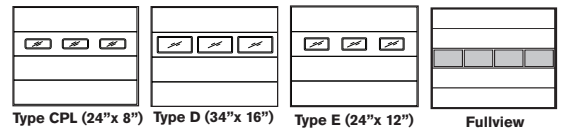

Type CPL (24" x 8") Type D (34" x 16") Type E (24" x 12") Fullview

## WARRANTY

**10 years against delamination of the panels**  
**1 year on materials and workmanship**

## SECTION SCHEDULE

DOOR OPENING HEIGHT	Sections High	DOOR OPENING WIDTH	Default Number of Windows
7'-1" to 8'-1" (2159mm to 2464mm)	4	8'-0" to 9'-2" (2438mm to 2794mm)	2
8'-2" to 10'-1" (2489mm to 3073mm)	5	9'-3" to 12'-2" (2819mm to 3708mm)	3
10'-2" to 12'-1" (3099mm to 3683mm)	6	12'-3" to 16'-2" (3734mm to 4928mm)	4
12'-2" to 14'-1" (3708mm to 4293mm)	7	16'-3" to 19'-2" (4953mm to 5842mm)	5
14'-2" to 16'-1" (4318mm to 4902mm)	8	19'-3" to 24'-2" (5867mm to 7366mm)	6
16'-2" to 18'-1" (4928mm to 5512mm)	9	24'-3" to 28'-2" (7391mm to 8585mm)	7
18'-2" to 20'-1" (5537mm to 6121mm)	10	28'-3" to 32'-2" (8611mm to 9804mm)	8
20'-2" to 22'-1" (6147mm to 6731mm)	11	32'-3" to 38'-2" (9830mm to 11,633mm)	9

\*Thermal Values Calculated. \*\*For larger sizes, please consult factory.



# T200-20

The choice for durability and thermal efficiency in challenging environments. With a heavy duty 20-gauge exterior sheet, it has all you'd expect or need for a wide range of applications.

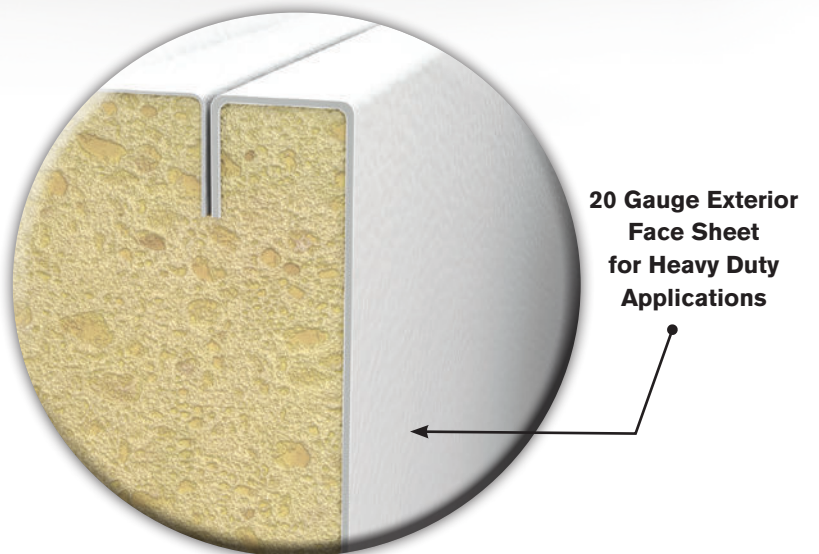

# PRODUCT SPECIFICATIONS

## SECTION DETAILS

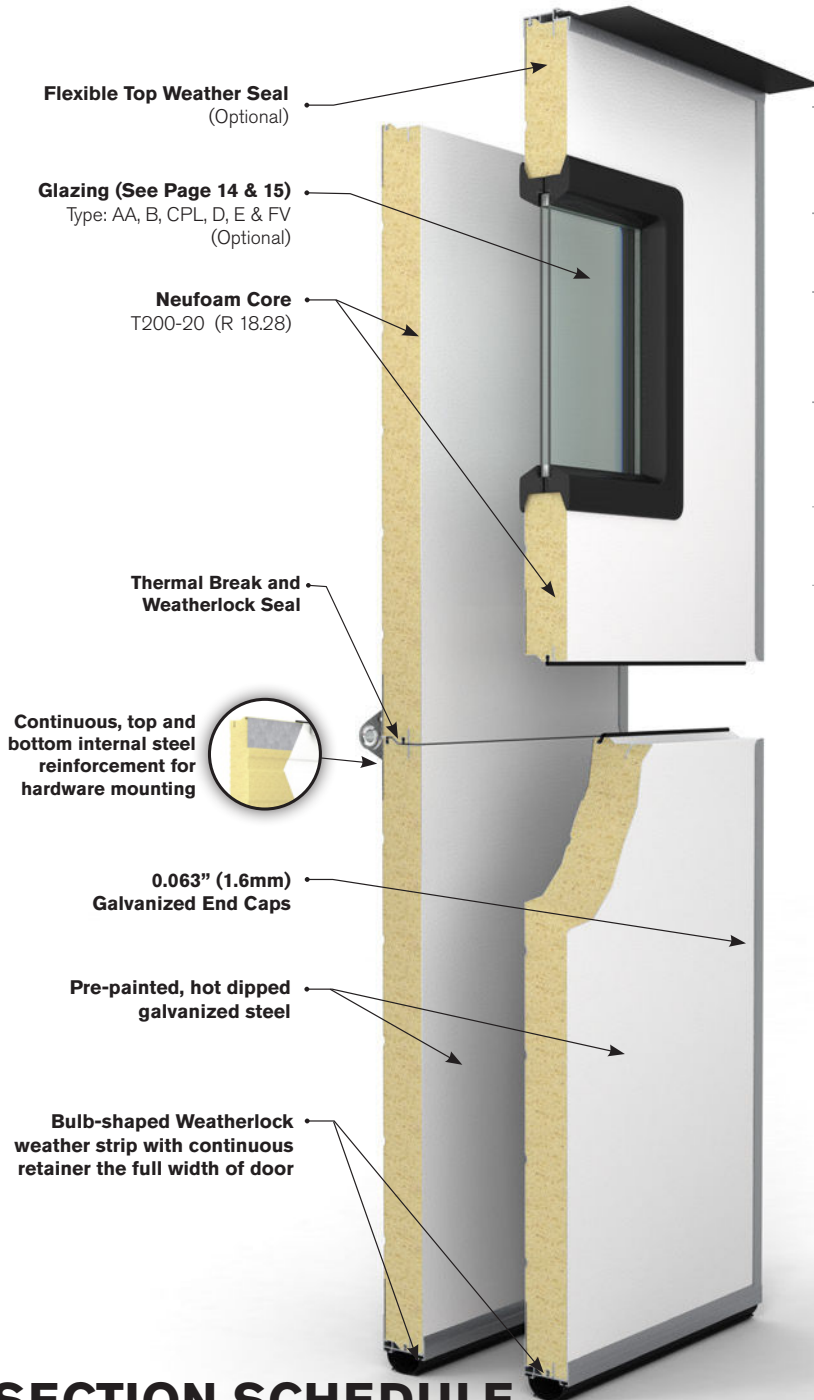

**SECTION THICKNESS** 2" (51mm)

**THERMAL VALUE OF SECTIONS\***  
R 18.28 ft<sup>2</sup> hF/Btu

**FACE SHEET PROFILE** Flush

**EXTERIOR FACE SHEET THICKNESS**  
20 Gauge (0.94 mm - 0.037")

**MAXIMUM OPENING WIDTH\*\***  
36'-2" (11,024mm)

**MAXIMUM OPENING HEIGHT\*** 22' (6706mm)

**FINISH** Two coat, baked-on paint system on exterior side, primer and polyester finish coat.



White

## GLAZING OPTIONS

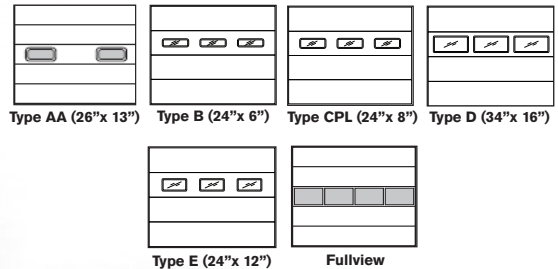

## SECTION SCHEDULE

DOOR OPENING HEIGHT	Sections High	DOOR OPENING WIDTH	Default Number of Windows
7'-1" to 8'-1" (2159mm to 2464mm)	4	8'-0" to 9'-2" (2438mm to 2794mm)	2
8'-2" to 10'-1" (2489mm to 3073mm)	5	9'-3" to 12'-2" (2819mm to 3708mm)	3
10'-2" to 12'-1" (3099mm to 3683mm)	6	12'-3" to 16'-2" (3734mm to 4928mm)	4
12'-2" to 14'-1" (3708mm to 4293mm)	7	16'-3" to 19'-2" (4953mm to 5842mm)	5
14'-2" to 16'-1" (4318mm to 4902mm)	8	19'-3" to 24'-2" (5867mm to 7366mm)	6
16'-2" to 18'-1" (4928mm to 5512mm)	9	24'-3" to 28'-2" (7391mm to 8585mm)	7
18'-2" to 20'-1" (5537mm to 6121mm)	10	28'-3" to 32'-2" (8611mm to 9804mm)	8
20'-2" to 22'-1" (6147mm to 6731mm)	11	32'-3" to 38'-2" (9830mm to 11,633mm)	9

## WARRANTY

**10 years against delamination of the panels**  
**1 year on materials and workmanship**

\*Thermal Values Calculated. \*\*For larger sizes, please consult factory.

# GLAZING OPTIONS



**B**

**CPL**

**AA**

**E**

**D**

TYPE	OVERALL DIMENSIONS	FRAME COLOUR	DESCRIPTION
<b>B</b>	24" x 6" 610mm x 152mm	Black or White*	Clear or Tempered glass sealed unit set in moulded frame.
<b>CPL</b>	24" x 8" 610mm x 203mm	Black or White*	Clear or Tempered glass sealed unit set in moulded frame.
<b>AA</b>	26" x 13" 660mm x 330mm	Black or White*	Dual acrylic unit set in moulded frame.
<b>E</b>	24" x 12" 610mm x 305mm	Black or White*	Clear or Tempered glass sealed unit set in moulded frame.
<b>D</b>	34" x 16" 864mm x 406mm	Black or White*	Clear or Tempered glass sealed unit set in moulded frame.

\*Other colours available upon request.

---

# ALUMINUM FULLVIEW SECTIONS

---

R-W can substitute any intermediate Thermatite panel with glass or polycarbonate lenses framed by an aluminum rail and stile system. This allows for natural great exposure to natural light.

## GLASS FULLVIEW GLAZING



**Rail Finish:** White, Anodized or Powder Coated.

**Glass:** 1/8" (3mm) and 1/2" (13mm) sealed or tempered units. Also available in Clear Lexan and 1/4" (6mm)

Obscure and Tinted glass available upon request.

**Maximum Width:** 24'-2"

## POLYCARBONATE FULLVIEW GLAZING



**Rail Finish:** Clear, White, Broze, Black, Anodized, RAL Powder Coated

**Lenses:** 5/8" (16mm) Three-Wall Polycarbonate and 1/4" (6mm) Clear Lexan

**Lense Colours:** Clear, Broznze, Western Brownze, White, Green or Blue

**Maximum Width:** 30'-2"  
(For larger sizes please consult factory)

# LINEAR HARDWARE & COMPONENTS

## STANDARD HARDWARE



### ROLLER BRACKETS

Linear type fabricated from 0.078" or 0.106" (2 or 2.7mm) galvanized steel. Graduated type design to ensure weather tight seal.

### HINGES

Linear type, fabricated from 0.078" (2 mm) thick galvanized steel with embossments designed to resist higher load and provide greater stability resulting in improved performance.



### TRACK

Roll formed from commercial galvanized steel. Vertical tracks sloped to ensure weather tight seal. Horizontal track curve available in 12" (305mm) - for 2" Hardware Only - or normally provided 16" (406mm) radius.

### HORIZONTAL ANGLE

Full length at 12" high or 144 sq. ft.



### TRACK BRACKETS

Bolted type, field adjustable, rib reinforced, stamped from 0.123" (3.1 mm) thick commercial galvanized steel.

### ROLLERS

Ball bearings provide years of smooth and quiet operation. 5/16" (8 mm) diameter standard stem, long stem on doors over 16'-2" (4928mm) wide.



### COUNTER BALANCE

Helically wound torsion springs manufactured from oil tempered spring wire, stress relieved, minimum 10,000 cycles. Aluminum die-cast grooved drums. Flexible 7 x 19 construction aircraft type galvanized cables with 5:1 safety factor. Higher cycle available upon request.

### TOP ROLLER CARRIER

Fabricated from galvanized steel designed to provide greater stability, field adjustable to ensure weather tight seal.

### TRUSSING

Doors are constructed to withstand wind load specified in ANSI/DASMA 108. Linear style trusses are provided according to door size. Additional trussing can be provided for higher wind load applications.

### SHAFTS

1" (25mm) diameter 0.078" (2mm) tube or 1/8" (3mm) wall keyed full length or 1" (25mm) diameter cold rolled galvanized steel keyed full length. 1-1/4" (31.75"mm) solid shaft also available.

### HEAD PLATES

Full height fabricated from galvanized steel, complete with bolt-on type bearings.

### LOCK

Interior slide bolt type.

### MOUNTING FASTENERS

Zinc plated.

### WEATHERSTRIPPING

Full length retainer and bulb weather strip minimize air flow and ensure weather-tightness at the base of your door.

## OPTIONAL COMPONENTS



- Combination PVC step plate and lift handle
- **Exhaust port:** 3" (76 mm) / 4" (102mm) / 5" (127mm) / 6" (125mm) diameter ports for T200. 3", 4" and 6" ports available for T300.
- Flexible top weather strip for full width of door
- Full height thermal break and anti-friction strip for galvanized end caps
- **Pass doors (T175 Only):** 32" x 80" (813mm X 2032mm) four section pass door available in doors up to 16'-2" (4928mm)



---

# COMMERCIAL OPERATORS

---

**RICHARD-WILCOX'S lineup of AC SERIES Jackshaft Belt, Gearhead and Trolley operators are perfect for any R-W Commercial Door**

## **AC SERIES MO-OSH**

Fills the gap between regular jackshaft and gearhead operators. This is an ultra high-end heavy-duty V-belt drive industrial operator designed for use on standard, high and vertical lift sectional doors.

## **AC SERIES MO-OGH**

Heavy-duty worm gear industrial operator designed for use on industrial standard, high and vertical lift sectional doors.

## **AC SERIES MO-OTBH**

Heavy-duty low headroom trolley operator designed for use on industrial standard lift sectional doors. It incorporates a drum-band type solenoid brake.

---

## **DC SERIES**

**The DC Series Direct drive Door Operator is a leap forward in DC operator design.**

It's easy to install, set up and trouble-shoot, this high cycle operator is loaded with features, yet remarkably reliable and simple to use.

### **Some Exceptional Standard Features Include:**

- Programmable Speed – up to 24"/second Opening Speed.
- Integral Load Sensing and Automatic, Time Delayed, Reversing Safety Feature.
- Adjustable Soft Stop Setting.
- Battery Backup.
- Smooth and Quiet Operation.
- Control Panel with Large LCD Display.
- Photo-Cell. (UL325 Compliant)
- Available in Jackshaft and Trolley Configurations.
- High Cycle. (Up to 1 million with minimal routine maintenance)
- Programmable "Service Due" Reminder.

### **Available in the following variations:**

- 1/2 HP for a 1" shaft
- 3/4 HP for a 1" shaft
- 3/4 HP for a 1.25" shaft
- 1 HP for a 1.25" shaft
- 2 HP for 1.25" shaft

---

**For more information about commercial operators  
visit [www.rwdoors.com/commercial-operators](http://www.rwdoors.com/commercial-operators)**

# CLEARANCE & MOUNTING REQUIREMENTS

DOOR STYLE	HARDWARE SIZE	HEADROOM REQUIRED	TRACK CURVE RADIUS	JAMB DETAILS			
				A	B	C	D
STANDARD LIFT	2" (51)	13" (330) to 19-1/2" (495)	12" (305) or 16" (406)	1-1/2" (38)	3-1/2" (89)	1" (25)	5" (127)
	3" (76)	18" (457), 19" (482) or 21" (533)	16" (406)	2" (51)	4" (102)	1" (25)	6" (152)
HI-LIFT	2" (51)	H.L. + 7-1/2" (191) to H.L. + 10" (254)	16" (406)	1-1/2" (38)	3-1/2" (89)	1" (25)	5" (127)
	3" (76)	H.L. + 9-1/2" (241) to H.L. + 18-1/2" (470)	16" (406)	2" (51)	4" (102)	1" (25)	6" (152)
VERTICAL LIFT	2" (51)	D.H. + 22" (559)	-	1-1/2" (38)	3-1/2" (89)	1" (25)	5" (127)
	3" (76)	D.H. + {22" (559) to 27-1/2" (699)}	-	2" (51)	4" (102)	1" (25)	6" (152)
LOW HEADROOM FRONT SPRINGS	2" (51)	11" (279) to 11-3/4" (298)	12" (305)	1-1/2" (38)	3-1/2" (89)	1" (25)	5" (127)
	3" (76)	13" (330) to 15-1/2" (394)	16" (406)	2" (51)	4" (102)	1" (25)	6" (152)
LOW HEADROOM REAR SPRINGS	2" (51)	5" (127) to 5-1/2" (140)	12" (305)	1-1/2" (38)	3-1/2" (89)	1" (25)	5" (127)
	3" (76)	7-1/2" (191)	16" (406)	2" (51)	4" (102)	1" (25)	6" (152)
LOW HEADROOM VERTICAL LIFT	2" (51)	D.H. + 10" (254) or D.H. + 4" (102)	-	1-1/2" (38)	3-1/2" (89)	1" (25)	5" (127)
	3" (76)	D.H. + 10" (254) or D.H. + 4" (102)	-	2" (51)	4" (102)	1" (25)	6" (152)

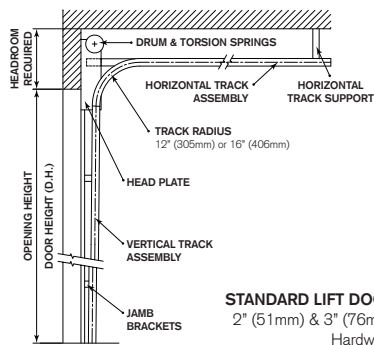

**STANDARD LIFT DOOR**  
2" (51mm) & 3" (76mm)  
Hardware

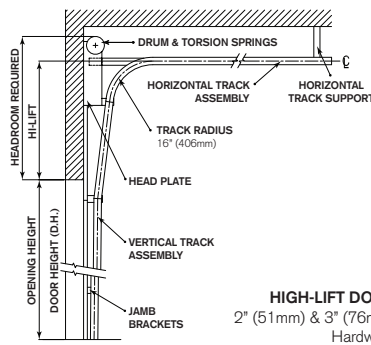

**HIGH-LIFT DOOR**  
2" (51mm) & 3" (76mm)  
Hardware

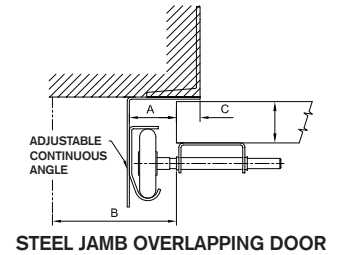

**STEEL JAMB OVERLAPPING DOOR**

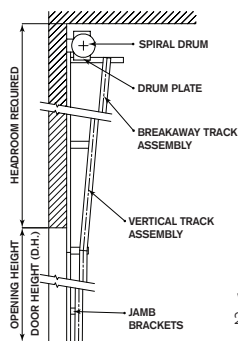

**VERTICAL LIFT DOOR**  
2" (51mm) & 3" (76mm)  
Hardware

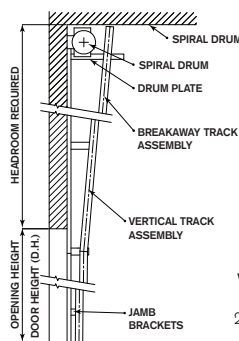

**VERTICAL LIFT DOOR  
LOW HEADROOM**  
2" (51mm) & 3" (76mm)  
Hardware

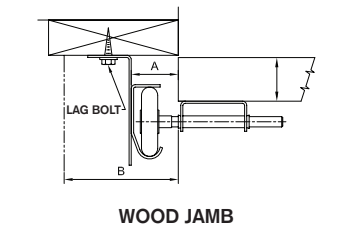

**WOOD JAMB**

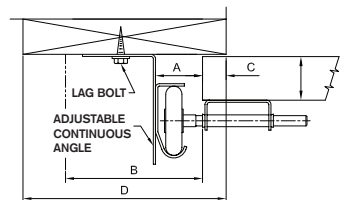

**WOOD JAMB OVERLAPPING DOOR**

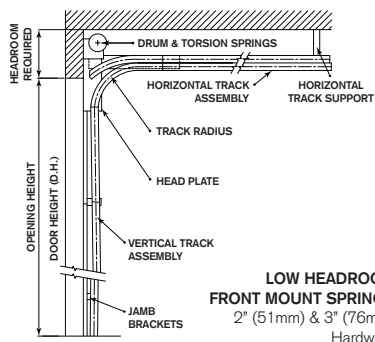

**LOW HEADROOM  
FRONT MOUNT SPRINGS**  
2" (51mm) & 3" (76mm)  
Hardware

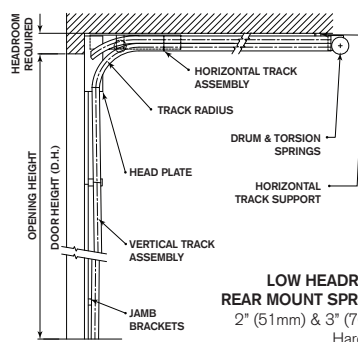

**LOW HEADROOM  
REAR MOUNT SPRINGS**  
2" (51mm) & 3" (76mm)  
Hardware

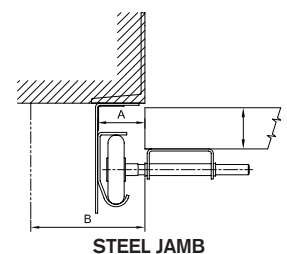

**STEEL JAMB**

# HARDWARE SPECIFICATIONS

## INDUSTRY STANDARD 2" (51MM) HARDWARE

### FINISH

All door face hardware, tracks, track mounting hardware and torsion assembly mounting brackets to be fabricated from commercial galvanized steel.

### TRACK

Roll formed from 0.078" (2mm) thick commercial galvanized steel, 2 1/8" (54mm) overall outside dimension. Vertical tracks sloped to ensure weather tight seal. Horizontal track curve available in 12" (305 mm) or normally provided 16" (406mm) radius.

### LIFT TYPE

Standard-Lift, High-Lift, Vertical-Lift, Low-Headroom: Front and Rear mount springs. For inclined tracks, consult customer service.

### VERTICAL TRACK MOUNTING

#### TRACK BRACKETS (STANDARD)

Bolted type, field adjustable, rib reinforced, stamped from 0.123" (3.1mm) thick commercial galvanized steel.

#### CLIP ANGLE MOUNT (OPTIONAL)

Pre-punched angle and clips, field adjustable to ensure weather tight seal and serviceability. The angles are fabricated from 0.093" (2.4mm) commercial galvanized steel.

#### ADJUSTABLE CONTINUOUS ANGLE ADCA (OPTIONAL)

Bolted type, field adjustable to ensure weather tight seal and serviceability, fabricated from 0.093" (2.4mm) commercial galvanized steel, designed to provide continuous support to the vertical tracks.

### TRACK HANGERS (OPTIONAL)

Perforated type 1 1/4" x 1 1/4" (32mm x 32mm) angles roll formed from 0.078" (2mm) thick commercial galvanized steel.

### ROLLERS

1 13/16" (46mm) diameter with ten 1/4" (6.3mm) diameter ball bearings, hardened steel race, 7/16" (11mm) diameter standard stem, long stem on doors over 16'-2" (4928mm) wide.

### HINGES

Linear type, fabricated from 0.078" or 0.106" (2 or 2.7mm) thick galvanized steel with embossments designed to resist higher load and to provide greater stability that results in improved performance.

### TOP ROLLER CARRIER

Fabricated from galvanized steel designed to provide greater stability, field adjustable to ensure weather tight seal.

### ROLLER BRACKETS

Linear type fabricated from 0.078" or 0.106" (2 or 2.7mm) galvanized steel. Graduated type design to ensure weather tight seal.

### COUNTER BALANCE

Helically wound torsion springs manufactured from oil tempered spring wire, stress relieved, minimum 10,000 cycles. Aluminum die-cast grooved drums. Flexible 7 x 19 construction aircraft type galvanized cables with 5:1 safety factor.

### SHAFTS

1" (25mm) diameter 0.078" (2mm) tube or 1/8" (3mm) wall keyed full length or 1" (25mm) diameter cold rolled galvanized steel keyed full length.

### HEAD PLATES

Full height fabricated from 0.093" (2.4mm) galvanized steel, complete with bolt-on type bearings

### LOCKING

Interior slide bolt type.

### HORIZONTAL ANGLE

72" (1829mm) long.

### MOUNTING FASTENERS

Zinc plated.

### WARRANTY

One (1) year.

## INDUSTRY STANDARD 3" (76MM) HARDWARE

### FINISH

All door face hardware, tracks, track mounting hardware and torsion assembly mounting brackets to be fabricated from commercial galvanized steel.

### TRACK

Roll formed from 0.108" (2.7mm) thick commercial galvanized steel, 3 1/8" (80mm) overall outside dimension. Vertical tracks sloped to ensure weather tight seal. Horizontal track curve radius 16" (406mm).

### LIFT TYPE

Standard-Lift, High-Lift, Vertical-Lift, Low-Headroom: Front and Rear mount springs. For inclined tracks, consult customer service.

### VERTICAL TRACK MOUNTING

#### TRACK BRACKETS (STANDARD)

Bolted type, field adjustable, rib reinforced, stamped from 0.123" (3.1mm) thick commercial galvanized steel.

#### CLIP ANGLE MOUNT (OPTIONAL)

Pre-punched angle and clips, field adjustable to ensure weather tight seal and serviceability. The angles are fabricated from 0.093" (2.4mm) commercial galvanized steel.

#### ADJUSTABLE CONTINUOUS ANGLE ADCA (OPTIONAL)

Bolted type, field adjustable to ensure weather tight seal and serviceability, fabricated from 0.093" (2.4mm) commercial galvanized steel, designed to provide continuous support to the vertical tracks.

### TRACK HANGERS (OPTIONAL)

Perforated type 1 1/4" x 1 1/4" (32mm x 32mm) angles roll formed from 0.078" (2mm) thick commercial galvanized steel.

### ROLLERS

2 7/8" (73mm) diameter with ten 5/16" (7.9mm) diameter ball bearings, hardened steel race. 7/16" (11mm) diameter standard stem, long stem on doors over 16'-2" (4928mm) wide.

### HINGES

Linear type, fabricated from 0.078" (2mm) thick galvanized steel with embossments designed to resist higher load and to provide greater stability that results in improved performance.

### TOP ROLLER CARRIER

Fabricated from galvanized steel designed to provide greater stability, field adjustable to ensure weather tight seal.

### ROLLER BRACKETS

Linear type fabricated from 0.078" or 0.106" (2 or 2.7mm) galvanized steel. Graduated type design to ensure weather tight seal.

### COUNTER BALANCE

Helically wound torsion springs manufactured from oil tempered spring wire, stress relieved, minimum 10,000 cycles. Aluminum die-cast grooved drums. Flexible 7 x 19 construction aircraft type galvanized cables with 5:1 safety factor.

### SHAFTS

1" (25mm) diameter 0.078" (2mm) tube or 1/8" (3mm) wall keyed full length or 1" (25mm) diameter cold rolled galvanized steel keyed full length or 1 1/4" (32mm) cold rolled steel keyed full length.

### HEAD PLATES

Full height fabricated from 0.093" or 0.123" (2.4 or 3.1mm) galvanized steel, complete with bolt-on type bearings.

### LOCKING

Interior slide bolt type.

### HORIZONTAL ANGLE

90" (2286mm) long.

### MOUNTING FASTENERS

Zinc plated.

### WARRANTY

One (1) year.

## HARDWARE OPTIONS: 2" (51MM) & 3" (76MM)

### PUSHER SPRING

Recommended for medium and large size standard lift doors with manual chain hoist and for all doors with Jackshaft type electric operators.

### BUMPER SPRING

Recommended for small standard lift doors with manual chain hoist or Jackshaft type electric operators.

### BUMPER LEAF SPRINGS

Recommended for high lift and vertical lift door applications.

### ACROSS THE DOOR BAR LATCH

Complete with night lock with an outside cylinder and handle (recommended for manually operated doors only).

### ACROSS-THE-DOOR BAR LATCH INSIDE ONLY

Complete with night lock and interior handle. Electric interlock is required on electrically operated doors.

### DOUBLE END ROLLER BRACKETS AND LONG STEM ROLLERS

Standard on doors wider than 16'-2" (4928mm).

### ROLLERS

2" (51mm): white nylon tire, 11 ball bearings, zinc plated stem available in standard and long stem.

3" (76mm): UHMW tire, precision sealed bearing, zinc plated stem available in long stem.

### CHAIN HOIST

Chain and sprocket type design, recommended on doors over 144 sq. ft (13.4 sq. m).

#### 2000R

Wall mountable, 4:1 reduction, available for 1" (25mm) or 1 1/4" (32mm) keyed shaft.

#### JR

Shaft mountable, 4:1 reduction, available for 1" (25mm) and 1 1/4" (32mm) keyed shaft.

#### JRG

Shaft mountable, 4.5:1 reduction, available for 1" (25mm) and 1 1/4" (32mm) keyed shaft.

### FOLLOW THE ROOF PITCH

Track to follow roof pitch for standard lift and high lift.

### HIGHER CYCLE TORSION SPRING ASSEMBLIES

25,000, 50,000, 75,000 or 100,000 cycle torsion springs assemblies, recommended with 1" (25mm) or 1 1/4" (32mm) solid steel shaft with full key-way, shaft mounted in self-aligning flange bearings, flexible 7 x 19 construction aircraft type galvanized cables.

### TRACK GUARDS

Formed from 3/16" (4.8mm) thick steel, 5'-0" (1524mm) high, chamfered top edge at 45 degree, grey finish. Optional: Baked yellow finish.

### PULL CHAIN WITH SPRING

Recommended for manually operated doors only.

### PERIMETER WEATHER-STRIP

Double fin white, black, brown, taupe or almond vinyl with steel retainer for jambs and lintel.

Double fin black vinyl with aluminum retainer for jambs and lintel.

ADCA bolt-on dual durometer black vinyl jamb seal recommended with section mounted top seal.

### CABLE FAIL SAFETY BRACKET

Designed to stop the door from free fall in case of cable failure.

### SPRING FAIL SAFETY DEVICE

Designed to stop the door shaft, thus the free fall of the door in case of spring failure, available with or without interlock switch to disconnect power to the electric operator.

### EXHAUST PORT

Aluminum die cast available in 3" (76mm), 4" (102mm) and 5" (127mm) diameter.

### FULL LENGTH HORIZONTAL ANGLE

Designed to support full length of the track.

**Consistent with our policy of continuing product improvement, we reserve the right to make appropriate modifications without notice.**



**For more information on our Commercial Sectional Overhead Doors,  
please contact your local R-W dealer.**

Professionally installed and serviced by:

## **RICHARDS-WILCOX Garage Doors**

5100 Timberlea Boulevard, Mississauga, Ontario Canada L4W 2S5

Toll Free: 1 (800) 667-1572 | Telephone: (905) 625-0037  
Fax: (905) 625-0057 | Email: [info@rwdoors.com](mailto:info@rwdoors.com)

**[www.rwdoors.com](http://www.rwdoors.com)**

ARCAT<sup>®</sup>

Member  
**DASMA**  
Door & Access Systems  
Manufacturers Association  
International

**GIDA**

April 2025 | 1-0011B-CDE

Specifications subject to change without notice.